

Varenummer: 2969600083
Beskrivelse: Flange type C for gear A60./F60.

Mål

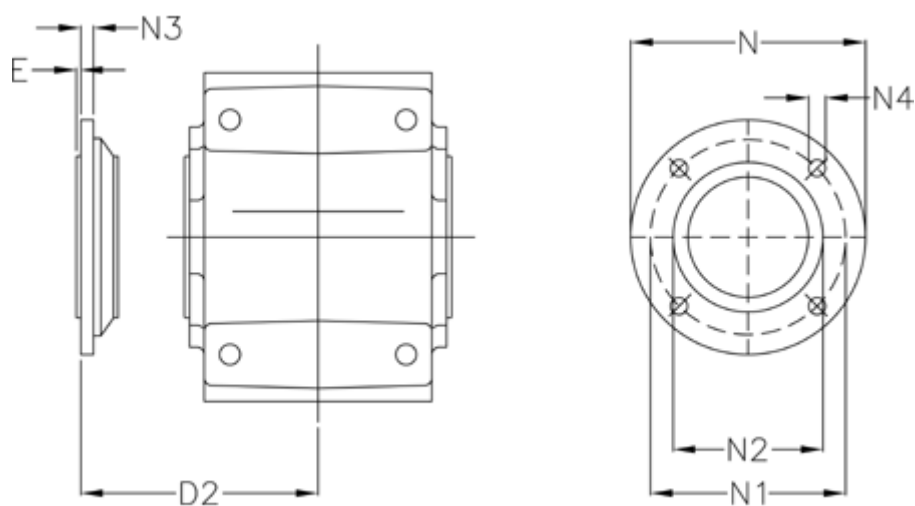

Betegnelse = Flange C for A60.

D2 = 170.0

E = 5.0

N = 400

N1 = 350

N2 = 300

N3 = 20

N4 = 18